

CATALOG NO.

PT0801-GR

First Edition

INSTRUCTIONS FOR ADDING 29480BFD OIL RETURN PUMP

styles

56100

56300

56500

56900



From the library of: Diamond Needle Corp



Union Special
INDUSTRIAL SEWING EQUIPMENT

03-25-09



**Installing New Oil Return Pump
29480BFD
in 56000 series machines**

DISASSEMBLY

- 1) Drain oil from machine using oil plug **A** (fig 1)

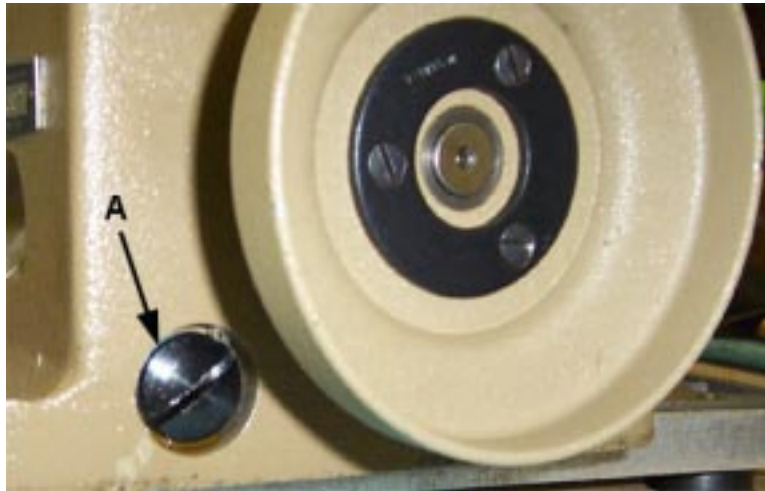

Fig 1

- 2) Remove lower crank chamber cover **B** (fig 2)



Fig 2

DISASSEMBLY CONT'D

3) Measure the distance between the right side of the head of the mainshaft and the left side of the machine bed and add shims to equal this measurement. (fig 3) This will help to keep the shafts, take-up and connecting rods in their proper position.

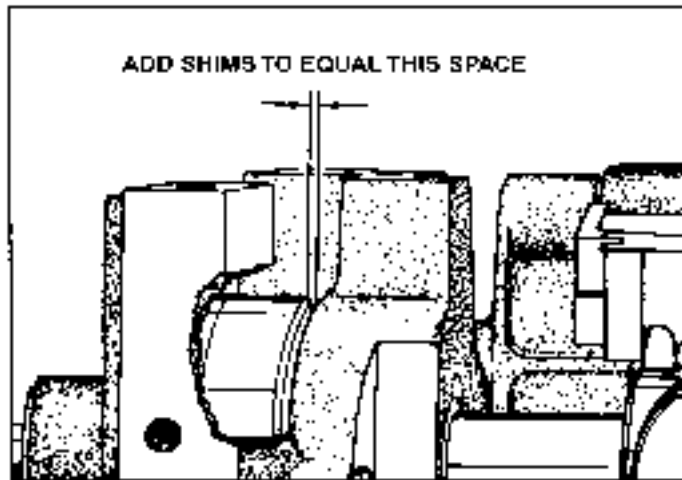

Fig 3

4) Remove handwheel assembly, bearing housing with 2 thrust washers, 1 thrust bearing and 1 brass pilot ring on each side and thrust collar. (fig 4)
Note: Thrust collar will not be used with new pump assembly.



Fig 4

**ASSEMBLY
of
NEW OIL RETURN PUMP
29480BFD**

- 1) Locate New pump assembly 29480BFD (fig 5)

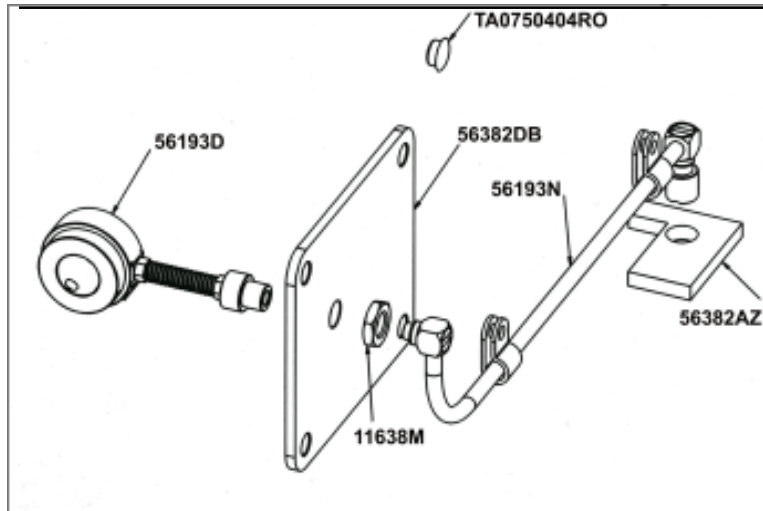

Fig 5

- 2) Install pump onto crankshaft, with hub side, with screws, to the outside. Carefully bend over the tubing and push the pump all the way onto the crankshaft and into the casting. (fig 6).

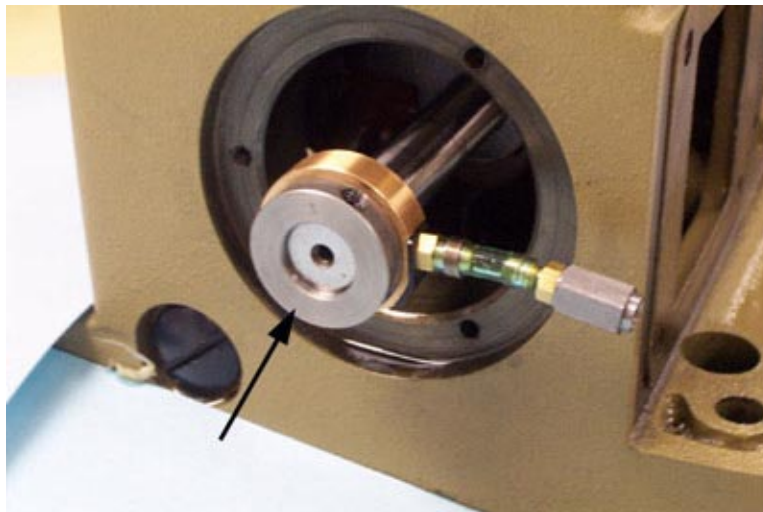

Fig 6

3) Install the bearing housing with its gasket, 1 set of thrust washers, bearings and brass pilot rings on each side, onto the crankshaft and tighten with its 3 screws. (fig 7). Note: make sure that the large oil hole in the housing is facing up.

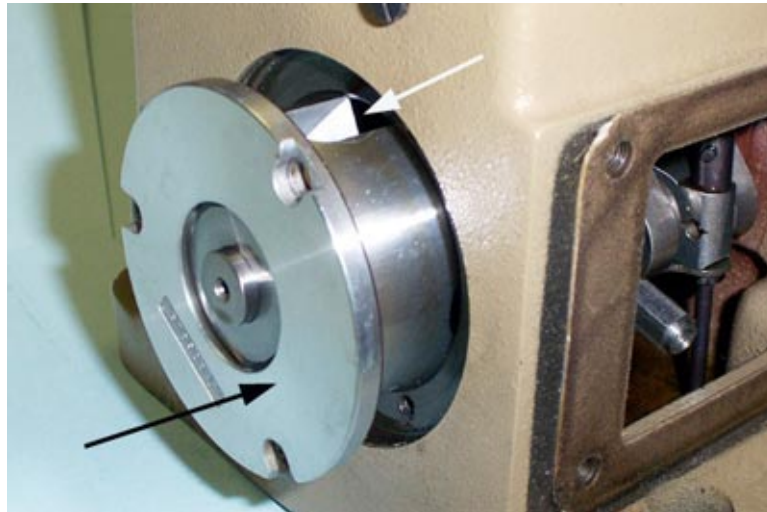

Fig 7

4) Holding the shafts in position with the shims as indicated in Fig 3, move the pump assembly **C** against the inside of the bearing housing **D** and tighten the 2 allens screws in the pump hub. Remove shims added in Fig 3.

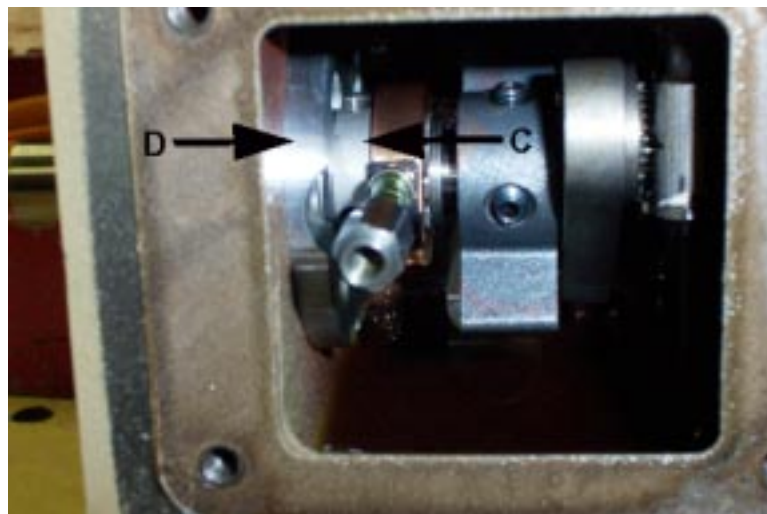

Fig 8

5) Install the handwheel assembly onto the crankshaft. Holding the pump hub against the inside of the bearing housing, carefully push the handwheel assembly against the outside of the housing and tighten the first screw in operating direction of the handwheel assembly against the flat on the crankshaft, then tighten the second screw. (fig 9). Turn the handwheel over several revolutions and check for binds or left to right shake. If binds or shake occur, repeat Step 5.

When the pump and handwheel are assembled correctly there should be a small amount of shake in the connecting rod caps, the take-up cam should be centered in the cast off plate, but no shake or binds in the crankshaft during a full rotation.

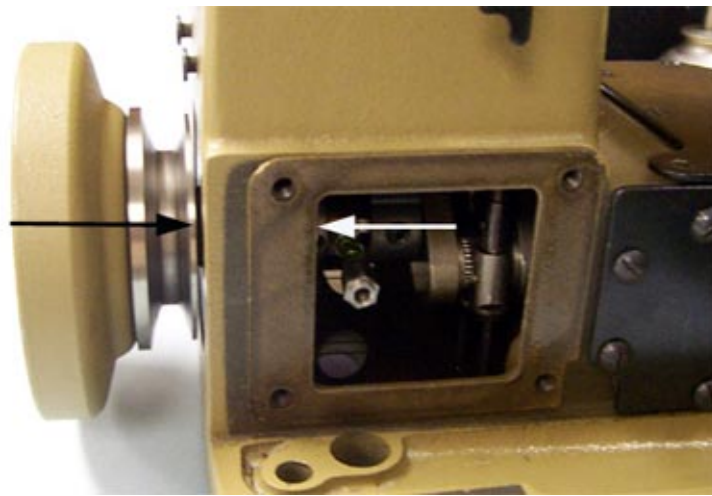

Fig 9

6) Align the oil fitting from the oil pump **E** (fig 10) with the hole **F** in the New lower crank chamber cover.

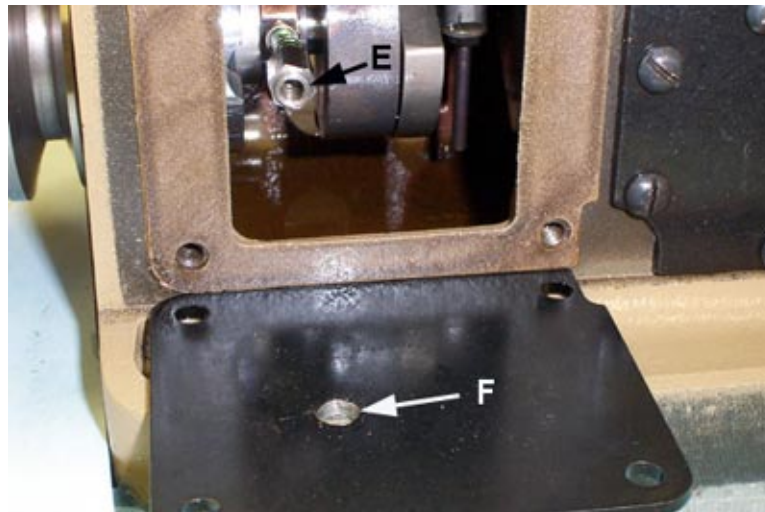

Fig 10

7) Attached nut G (fig 11) to oil fitting from oil pump thru New crank chamber cover and gasket and tighten. Attach oil tube fitting H into the oil fitting from the oil pump as shown and tighten. Attach the crank chamber cover and gasket to the machine with its 4 screws. Screw I will go thru the white plastic oil tube clamp to hold the tubing in place.



Fig 11

8) Place felt for oil return pump in the back of machine under brass oil tube as shown. (fig 12). Note: If internal oil return pump and brass tube have been removed, used plug TA0750404RO in hole in back cover.

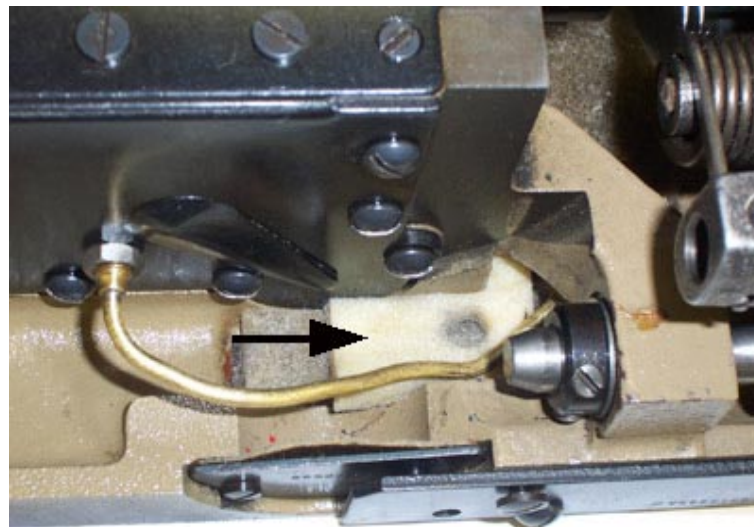

Fig 12

9) Run the oil tube along the back of the machine and under the brass oil tube. (fig 13). Remove screw **J** from the back reservoir cover and slide the screw into the white oil tube clamp. Replace screw with clamp, snug but do not tighten at this time.

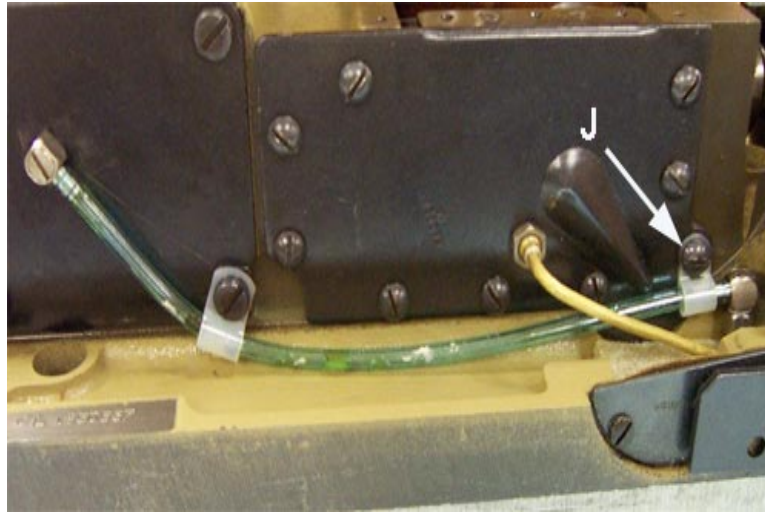

Fig 13

10) Push the oil fitting **K** (fig 14) so that the bottom of the fitting fits in the hole in the felt and against the felt of the machine and then tighten screw **J** securely.

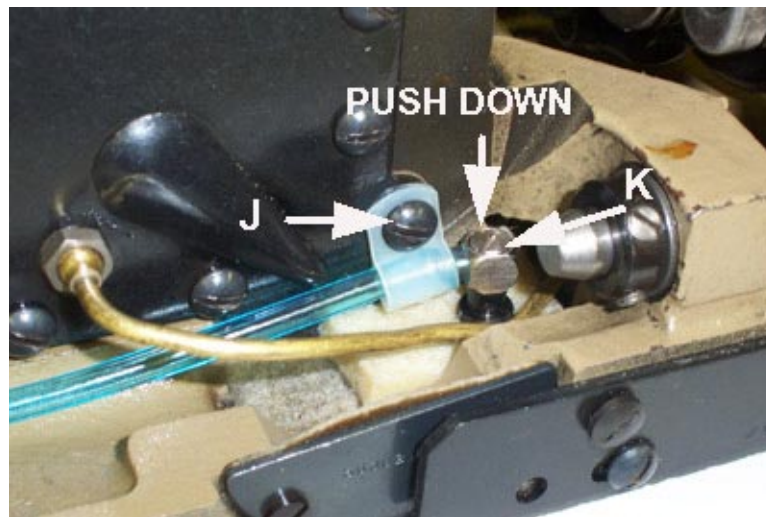

Fig 14

11) Add the proper amount of Union Special Spec 175 oil to the machine and run slowly to help prime the pump. If the machine felt is dry, add a small amount of machine oil at the oil fitting to help start the oil flow to the pump.